

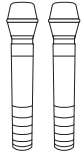

WIRELESS MICROPHONE RECEIVER



Connect to MIC. receiver (Rear MIC. 4)

Connect to MIC. receiver (Rear MIC. 5)

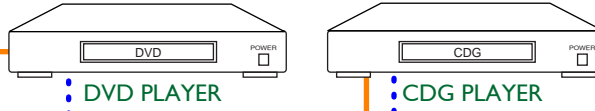

DVD PLAYER

CDG PLAYER

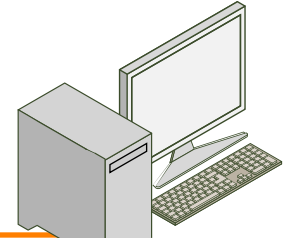

PC SOURCE

BGM (BackGround Music)

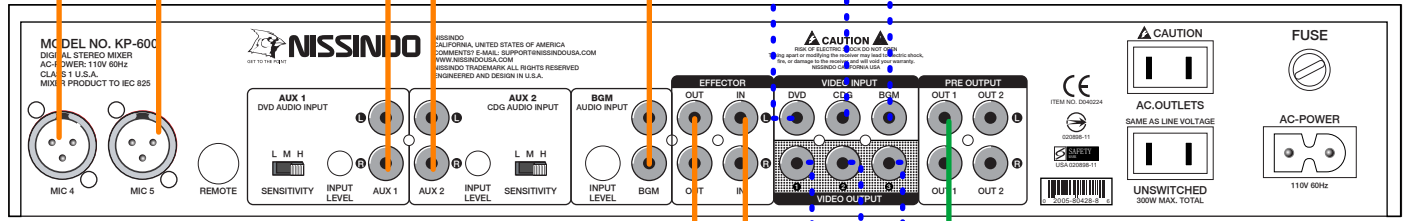

KP-600

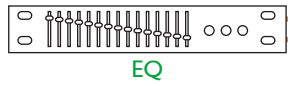

Audio Cable Size XLR (M) to RCA (M)

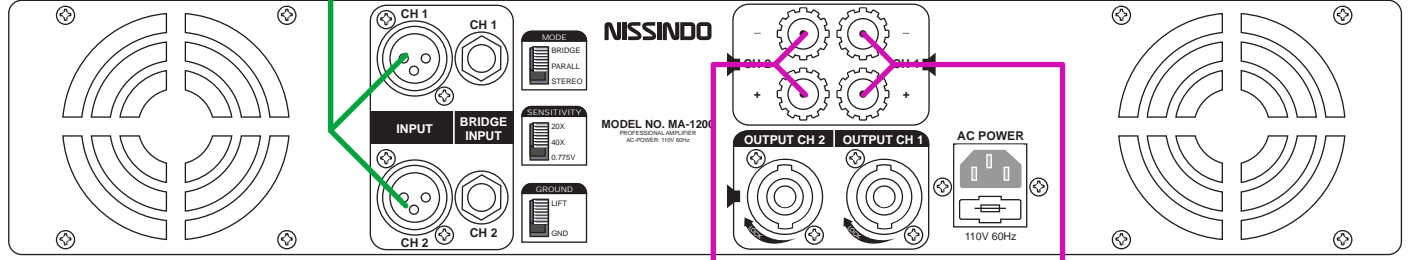

MA-1200

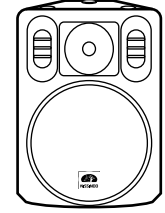

MAIN SPEAKER LEFT

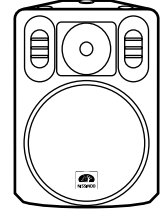

MAIN SPEAKER RIGHT



WIRELESS MICROPHONE RECEIVER

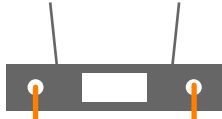
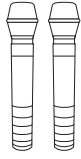

Connect to MIC. receiver (Rear MIC. 4)

Connect to MIC. receiver (Rear MIC. 5)

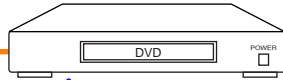

DVD PLAYER

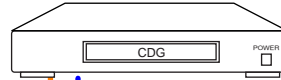

CDG PLAYER

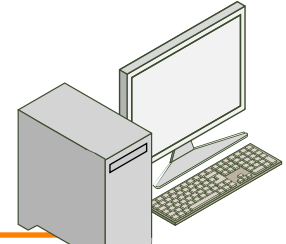

PC SOURCE

BGM (BackGround Music)

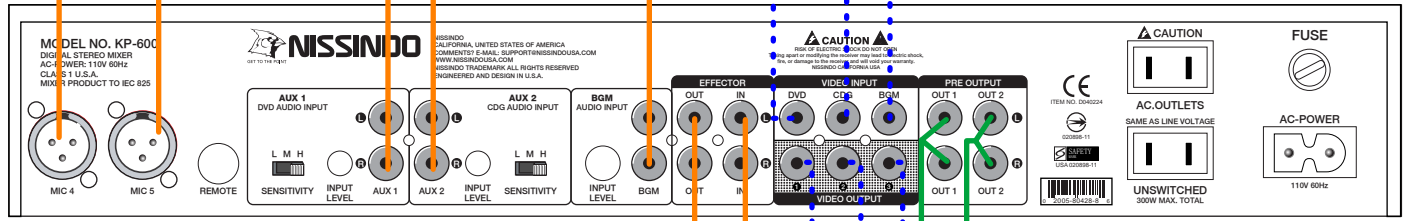

KP-600

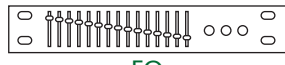

EQ

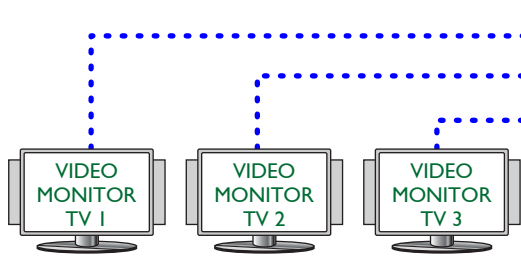

Composite Video

Composite Video

Composite Video

Audio Cable Size XLR (M) to RCA (M)

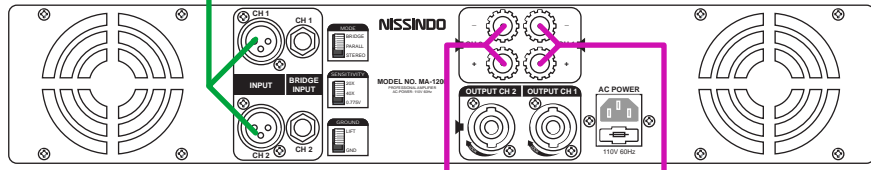

MA-1200

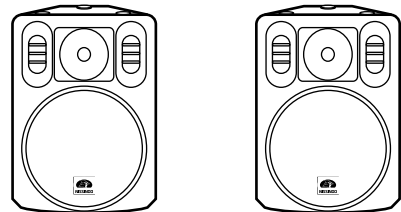

MAIN SPEAKER LEFT MAIN SPEAKER RIGHT

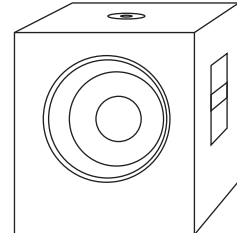

SUBWOOFER
BUILT-IN POWERED SUB

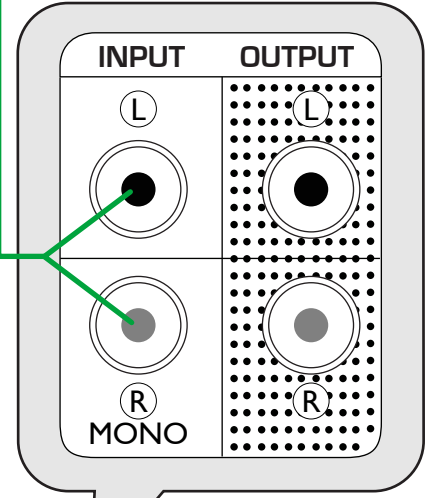

Audio Cable Size XLR (M) to RCA (M)

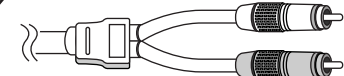

MONO Adaptor

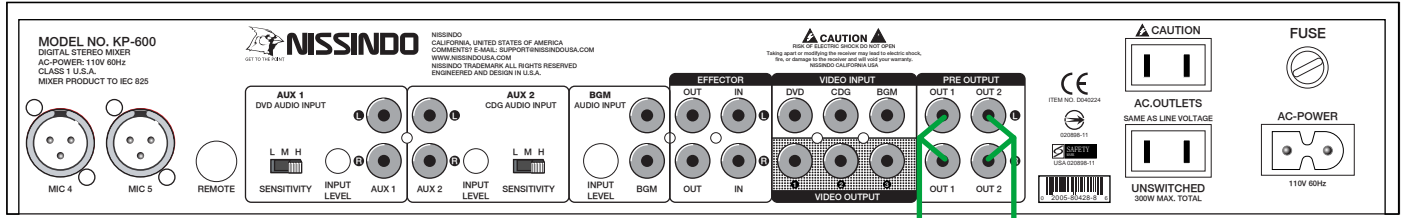

KP-600

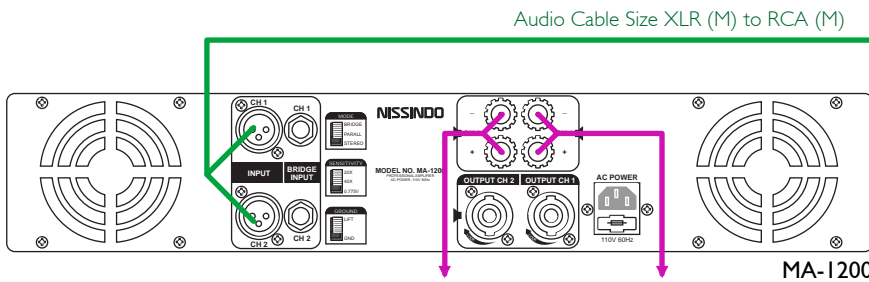

MA-1200

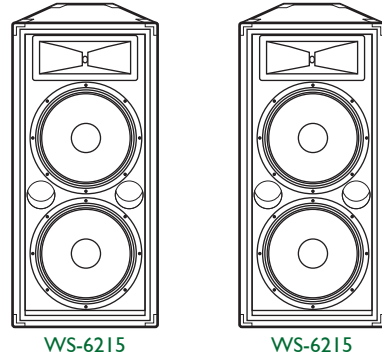

Audio Cable Size XLR (M) to RCA (M)

If you use it indoor for area of 3,000 square feet or outdoor, we recommend you using two power amplifiers to drive the four speakers. Please refer to the next diagram for connection.

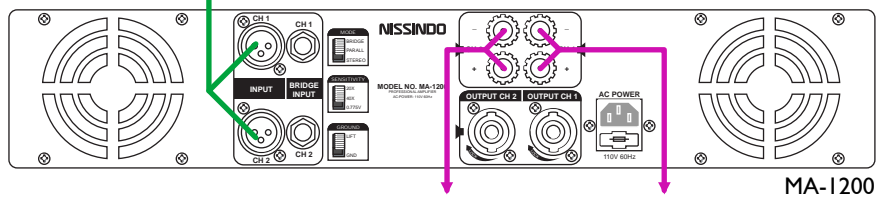

MA-1200

